

Draw-Bar Frame Price List

January 2021

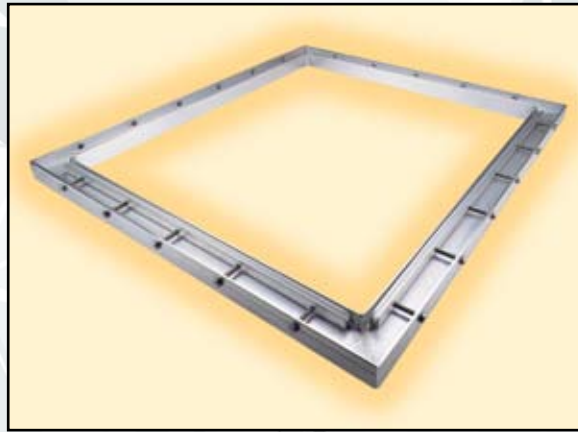

DRAW-BAR FRAME PRICE LIST

January 2021

WC-10

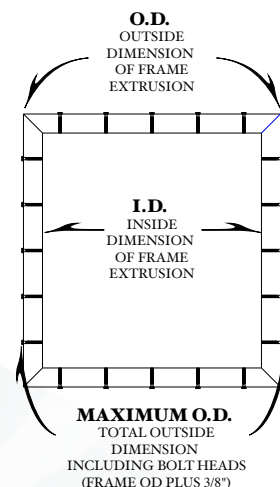
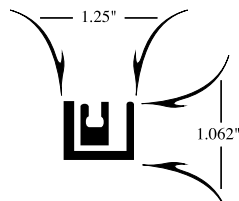

Max Size: 20"
 Width: 1.25"
 Height: 1 1/16"
 Weight per Ft: 1.0 Lbs
 ID to OD Conv: 2 1/2"
 ID to Max OD : 2 7/8"

Total Frame O.D. or Max O.D. Inches									
40	42	44	46	48	50	52	54	56	58
\$137.50	138.50	146.00	147.00	148.00	155.50	156.50	157.50	165.00	166.00
60	62	64	66	68	70	72	74	76	78
175.00	176.00	177.00	184.00	185.00	186.00	187.00	194.00	195.00	196.00
80	82	84	86	88	90	92	94	96	98
203.50	204.50	205.50	213.00	214.00	215.00	223.00	224.00	225.00	232.50
100	102	104	106	108	110	112	Frames Over 112" O.D.		
233.50	234.50	242.00	243.00	244.00	251.50	252.50	\$ 2.25 per O.D. Inch		
1 to 12 List Price				13 to 24 Less 5%		25 or more Less 10%			

Total Frame I.D. Inches									
30	32	34	36	38	40	42	44	46	48
\$137.50	138.50	146.00	147.00	148.00	155.50	156.50	157.50	165.00	166.00
50	52	54	56	58	60	62	64	66	68
175.00	176.00	177.00	184.00	185.00	186.00	187.00	194.00	195.00	196.00
70	72	74	76	78	80	82	84	86	88
203.50	204.50	205.50	213.00	214.00	215.00	223.00	224.00	225.00	232.50
90	92	94	96	98	100	102	Frames Over 102" I.D.		
233.50	234.50	242.00	243.00	244.00	251.50	252.50	\$ 2.50 per I.D. Inch		
1 to 12 List Price				13 to 24 Less 5%		25 or more Less 10%			

Draw-Bar Options



Keystone Nylon Replacement Bars \$ 1.20 inch
 Replacement Rods .15 inch

Hardware Options



Hex Head Replacement Bolt Set \$ 1.50 ea



Recessed Allen Replacement Bolt Set \$ 1.50 ea



Allen Head Replacement Bolt Set \$ 1.50 ea
 (Limited Supply)

Eino / Diamond Chase
 (800) 245-5283 ph
 (626) 969-1821 ph
 (626) 969-1599 fax

418 South Motor Ave.
 Azusa, CA 91702

Additional 5% for New Frames with Recessed Allen Bolts
 \$5.00 per Add'l Hole for Frames with 4" Bolt Centers
 Prices Subject to Change without Notice

DRAW-BAR FRAME PRICE LIST



WC-20

January 2021

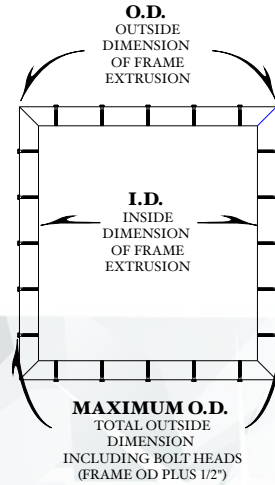
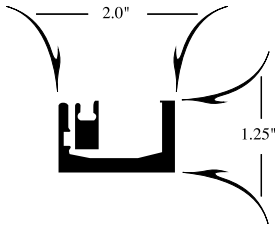

Max Size: 30"
 Width: 2"
 Height: 1 1/4"
 Weight per Ft: 1.6 Lbs
 ID to OD Conv: 4"
 ID to Max OD : 4 1/2"



Total Frame O.D. or Max O.D. Inches

100 \$306.00	102 308.00	104 318.00	106 319.50	108 321.00	110 331.00	112 333.00	114 334.00	116 344.50	118 346.00
120 347.50	122 357.50	124 359.00	126 360.50	128 371.00	130 372.50	132 374.00	134 384.00	136 386.00	138 387.00
140 397.50	142 399.00	144 400.00	146 410.00	148 412.50	150 414.00	152 424.00	154 425.00	156 427.00	158 437.00
160 438.50	162 440.00	164 450.00	166 452.00	168 453.50	170 463.50	172 465.00	Frames Over 172" O.D. \$2.70 per O.D. Inch		
1 to 5 List Price			6 to 11 Less 5%		12 to 17 Less 7.5%		18 or more Less 10%		

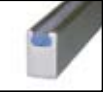

Total Frame I.D. Inches

84 \$306.00	86 308.00	88 318.00	90 319.50	92 321.00	94 331.00	96 333.00	98 334.00	100 344.50	102 346.00
104 347.50	106 357.50	108 359.00	110 360.50	112 371.00	114 372.50	116 374.00	118 384.00	120 386.00	122 387.00
124 397.50	126 399.00	128 400.00	130 410.00	132 412.50	134 414.00	136 424.00	138 425.00	140 427.00	142 437.00
144 438.50	146 440.00	148 450.00	150 452.00	152 453.50	154 463.50	156 465.00	Frames Over 156" I.D. \$2.98 per I.D. Inch		
1 to 5 List Price			6 to 11 Less 5%		12 to 17 Less 7.5%		18 or more Less 10%		

Draw-Bar Options

	Top Loading Double Nylon Replacement Bars	\$ 1.35 inch
	Replacement Rods	.20 inch
	Keystone Nylon Replacement Bars	\$ 1.20 inch
	Replacement Rods	.15 inch
	Glue On Draw Bars	\$ 1.35 inch
	Replacement Glue Strip	.25 inch

Hardware Options

	Hex Head Replacement Bolt Set	\$ 2.00 ea
	Recessed Allen Replacement Bolt Set	\$ 2.00 ea
	Allen Head Replacement Bolt Set (Limited Supply)	\$ 2.00 ea

Additional 5% for New Frames with Recessed Allen Bolts
 \$5.00 per Add'l Hole for Frames with 4" Bolt Centers
 Prices Subject to Change without Notice

Eino / Diamond Chase
 (800) 245-5283 ph
 (626) 969-1821 ph
 (626) 969-1599 fax

418 South Motor Ave.
 Azusa, CA 91702

DRAW-BAR FRAME

PRICE LIST

WC-20 HD

January 2021

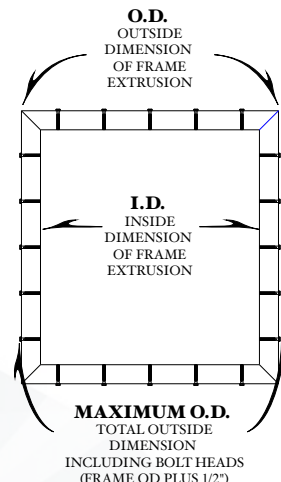
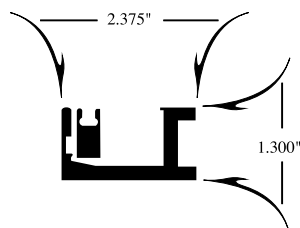

Max Size: 36"
 Width: 2 3/8"
 Height: 1 5/16"
 Weight per Ft: 1.9 Lbs
 ID to OD Conv: 4 3/4"



Total Frame O.D. or Max O.D. Inches

120 \$ 373.00	122 375.50	124 377.50	126 389.00	128 391.00	130 393.50	132 405.00	134 407.00	136 409.00	138 420.00
140 423.00	142 425.00	144 436.50	146 439.00	148 441.00	150 452.50	152 455.00	154 457.00	156 469.00	158 471.00
160 473.50	162 485.00	164 487.50	166 490.00	168 501.50	170 504.00	172 506.00	174 518.00	176 520.00	178 522.50
180 534.50	182 537.00	184 539.00	186 550.00	188 553.50	190 556.00	192 567.50	Frames Over 192" O.D. \$ 2.95 per O.D. Inch		
1 to 5 List Price			6 to 11 Less 5%		12 to 17 Less 7.5%		18 or more Less 10%		



Total Frame I.D. Inches

101 \$ 373.00	103 375.50	105 377.50	107 389.00	109 391.00	111 393.50	113 405.00	115 407.00	117 409.00	119 420.00
121 423.00	123 425.00	125 436.50	127 439.00	129 441.00	131 452.50	133 455.00	135 457.00	137 469.00	139 471.00
141 473.50	143 485.00	145 487.50	147 490.00	149 501.50	151 504.00	153 506.00	155 518.00	157 520.00	159 522.50
161 534.50	163 537.00	165 539.00	167 550.00	169 553.50	171 556.00	173 567.50	Frames Over 173" I.D. \$ 3.28 per I.D. Inch		
1 to 5 List Price			6 to 11 Less 5%		12 to 17 Less 7.5%		18 or more Less 10%		

Draw-Bar Options

	Top Loading Double Nylon Replacement Bars \$ 1.35 inch Replacement Rods .20 inch
	Keystone Nylon Replacement Bars \$ 1.20 inch Replacement Rods .15 inch
	Glue On Draw Bars Replacement Bars \$ 1.35 inch Replacement Glue Strip .25 inch

Hardware Options

	Hex Head (Raised Hex) Replacement Bolt Set \$ 3.00 ea
	Allen Head Replacement Bolt Set \$ 2.00 ea (Limited Supply)

Eino / Diamond Chase
 (800) 245-5283 ph
 (626) 969-1821 ph
 (626) 969-1599 fax

418 South Motor Ave.
 Azusa, CA 91702

Additional 5% for New Frames with Recessed Allen Bolts
 \$5.00 per Add'l Hole for Frames with 4" Bolt Centers
 Prices Subject to Change without Notice

DRAW-BAR FRAME PRICE LIST



T-175

January 2021

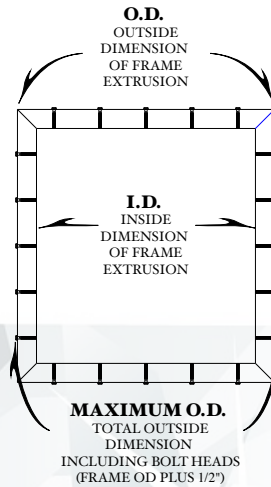
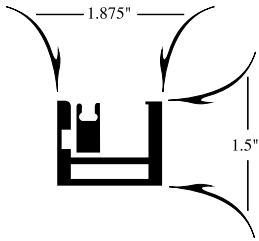

Max Size: 40"
 Width: 1 7/8"
 Height: 1 1/2"
 Weight per Ft: 1.85 Lbs
 ID to OD Conv: 3 3/4"
 ID to Max OD : 4 1/4"

Total Frame O.D. or Max O.D. Inches									
120	122	124	126	128	130	132	134	136	138
\$ 360.00	370.50	373.00	375.00	385.50	388.00	390.00	400.00	403.00	405.00
140	142	144	146	148	150	152	154	156	158
416.00	418.00	420.00	431.50	433.50	435.50	446.50	449.00	451.00	462.00
160	162	164	166	168	170	172	174	176	178
464.50	466.50	477.50	480.00	482.00	493.00	495.00	497.50	509.00	511.00
180	182	184	186	188	190	192	Frames Over 192" O.D.		
513.50	524.50	527.00	529.50	540.00	543.00	545.00	\$ 2.85 per O.D. Inch		
1 to 5 List Price			6 to 11 Less 5%			12 to 17 Less 7.5%			18 or more Less 10%

Total Frame I.D. Inches									
105	107	109	111	113	115	117	119	121	123
\$ 360.00	370.50	373.00	375.00	385.50	388.00	390.00	400.00	403.00	405.00
125	127	129	131	133	135	137	139	141	143
416.00	418.00	420.00	431.50	433.50	435.50	446.50	449.00	451.00	462.00
145	147	149	151	153	155	157	159	161	163
464.50	466.50	477.50	480.00	482.00	493.00	495.00	497.50	509.00	511.00
165	167	169	171	173	175	177	Frames Over 177" I.D.		
513.50	524.50	527.00	529.50	540.00	543.00	545.00	\$ 3.10 per I.D. Inch		
1 to 5 List Price			6 to 11 Less 5%			12 to 17 Less 7.5%			18 or more Less 10%

Draw-Bar Options

	Top Loading Double Nylon Replacement Bars	\$ 1.35 inch
	Replacement Rods	.20 inch
	Keystone Nylon Replacement Bars	\$ 1.20inch
	Replacement Rods	.15 inch
	Glue On Draw Bars Replacement Bars	\$ 1.35 inch
	Replacement Glue Strip	.25 inch

Hardware Options

	Hex Head Replacement Bolt Set	\$ 2.00 ea
	Recessed Allen Replacement Bolt Set	\$ 2.00ea
	Allen Head Replacement Bolt Set (Limited Supply)	\$ 2.00 ea

Additional 5% for New Frames with Recessed Allen Bolts
 \$5.00 per Add'l Hole for Frames with 4" Bolt Centers
 Prices Subject to Change without Notice

Eino / Diamond Chase
 (800) 245-5283 ph
 (626) 969-1821 ph
 (626) 969-1599 fax

418 South Motor Ave.
 Azusa, CA 91702

DRAW-BAR FRAME PRICE LIST

January 2021

T-175 HD

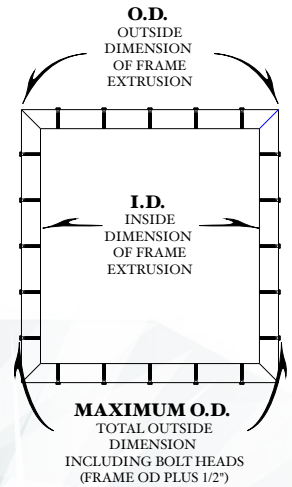
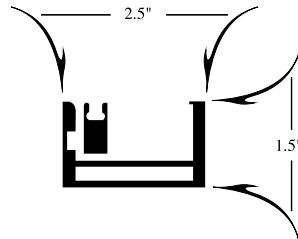

Max Size: 72"

Width: 2 1/2"

Height: 1 1/2"

Weight per Ft: 2.1 Lbs

ID to OD Conv: 5"

ID to Max OD : 5 1/2"

Total Frame O.D. or Max O.D. Inches

140	144	148	152	156	160	164	168	172	176
\$ 457.00	471.00	475.00	490.00	504.00	508.50	523.00	537.00	542.00	556.00
180	184	188	192	196	200	204	208	212	216
570.50	575.50	590.00	604.00	609.00	623.50	638.00	643.00	657.50	672.00
220	224	228	232	236	240	244	248	252	256
677.00	691.50	706.00	711.00	726.00	740.50	745.50	760.00	775.00	780.00
260	264	268	272	276	280	284	Frames Over 284" O.D.		
795.00	809.50	815.00	830.00	844.50	850.00	865.00	\$ 3.05 per O.D. Inch		
1 to 5 List Price			6 to 11 Less 5%			12 to 17 Less 7.5%		18 or more Less 10%	

Total Frame I.D. Inches

120	124	128	132	136	140	144	148	152	156
\$ 457.00	471.00	475.00	490.00	504.00	508.50	523.00	537.00	542.00	556.00
160	164	168	172	176	180	184	188	192	196
570.50	575.50	590.00	604.00	609.00	623.50	638.00	643.00	657.50	672.00
200	204	208	212	216	220	224	228	232	236
677.00	691.50	706.00	711.00	726.00	740.50	745.50	760.00	775.00	780.00
240	244	248	252	256	260	264	Frames Over 264" I.D.		
795.00	809.50	815.00	830.00	844.50	850.00	865.00	\$ 3.28 per I.D. Inch		
1 to 5 List Price			6 to 11 Less 5%			12 to 17 Less 7.5%		18 or more Less 10%	

Draw-Bar Options

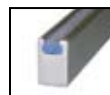

Top Loading Double Nylon
Replacement Bars \$ 1.35 inch
Replacement Rods .20 inch



Keystone Nylon
Replacement Bars \$ 1.20 inch
Replacement Rods .15 inch



Glue On Draw Bars
Replacement Bars \$ 1.35 inch
Replacement Glue Strip .25 inch

Hardware Options



Hex Head
Replacement Bolt Set \$ 2.00 ea



Recessed Allen
Replacement Bolt Set \$ 2.00 ea

Eino / Diamond Chase
(800) 245-5283 ph
(626) 969-1821 ph
(626) 969-1599 fax

418 South Motor Ave.
Azusa, CA 91702

Additional 5% for New Frames with Recessed Allen Bolts
\$5.00 per Add'l Hole for Frames with 4" Bolt Centers
Prices Subject to Change without Notice

DRAW-BAR FRAME PRICE LIST



UC-25

January 2021

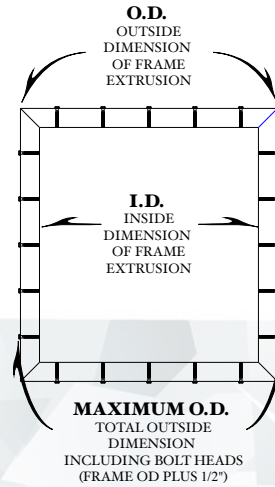
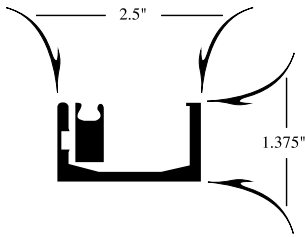

Max Size: 40"
 Width: 2 1/2"
 Height: 1 3/8"
 Weight per Ft: 1.8 Lbs
 ID to OD Conv: 5"
 ID to Max OD : 5 1/2"

Total Frame O.D. or Max O.D. Inches									
120	124	128	132	136	140	144	148	152	156
\$ 367.00	371.00	384.00	396.50	400.00	413.00	426.00	430.00	442.50	455.50
160	164	168	172	176	180	184	188	192	196
459.50	472.50	485.00	489.50	502.00	515.00	519.00	532.00	545.00	549.50
200	204	208	212	216	220	224	228	232	236
562.50	575.00	579.50	592.50	606.00	610.00	623.00	636.50	640.50	654.00
240	244	248	252	256	260	264	Frames Over 264" O.D.		
667.00	671.50	685.00	698.00	702.50	716.00	729.00	\$ 2.76 per O.D. Inch		
1 to 5 List Price		6 to 11 Less 5%		12 to 17 Less 7.5%		18 or more Less 10%			

Total Frame I.D. Inches									
100	104	108	112	116	120	124	128	132	136
\$ 367.00	371.00	384.00	396.50	400.00	413.00	426.00	430.00	442.50	455.50
140	144	148	152	156	160	164	168	172	176
459.50	472.50	485.00	489.50	502.00	515.00	519.00	532.00	545.00	549.50
180	184	188	192	196	200	204	208	212	216
562.50	575.00	579.50	592.50	606.00	610.00	623.00	636.50	640.50	654.00
220	224	228	232	236	240	244	Frames Over 244" I.D.		
667.00	671.50	685.00	698.00	702.50	716.00	729.00	\$ 2.99 per I.D. Inch		
1 to 5 List Price		6 to 11 Less 5%		12 to 17 Less 7.5%		18 or more Less 10%			

Draw-Bar Options



Top Loading Double Nylon
 Replacement Bars \$ 1.35 inch
 Replacement Rods .20 inch



Keystone Nylon
 Replacement Bars \$ 1.20inch
 Replacement Rods .15 inch



Glue On Draw Bars
 Replacement Bars \$ 1.35 inch
 Replacement Glue Strip .25 inch

Hardware Options



Hex Head
 Replacement Bolt Set \$ 2.00 ea



Recessed Allen
 Replacement Bolt Set \$ 2.00 ea

Additional 5% for New Frames with Recessed Allen Bolts
 \$5.00 per Add'l Hole for Frames with 4" Bolt Centers
 Prices Subject to Change without Notice

Eino / Diamond Chase
 (800) 245-5283 ph
 (626) 969-1821 ph
 (626) 969-1599 fax

418 South Motor Ave.
 Azusa, CA 91702

DRAW-BAR FRAME PRICE LIST

MODEL 260

January 2021

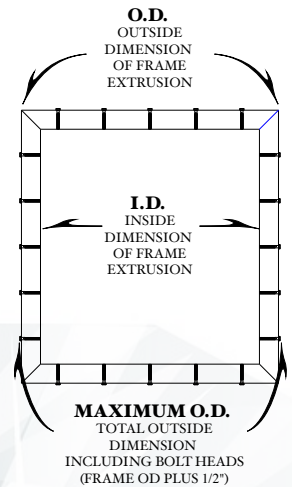
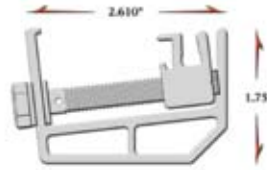

Max Size: 65"

Width: 2 5/8"

Height: 1 3/4"

Weight per Ft: 1.75 Lbs

ID to OD Conv: 5 1/4"

ID to Max OD : 5 3/4"

Total Frame O.D. or Max O.D. Inches

160 \$ 478.50	164 492.00	168 505.00	172 509.50	176 523.00	180 536.50	184 540.50	188 554.00	192 567.50	196 572.00
200 585.50	204 599.00	208 603.50	212 617.00	216 630.50	220 635.00	224 648.50	228 662.50	232 667.00	236 680.50
240 694.50	244 699.00	248 712.50	252 726.50	256 731.00	260 745.00	264 759.00	268 763.50	272 777.50	276 791.50
280 796.00	284 810.00	288 824.00	292 828.50	296 843.00	300 857.00	304 861.50	Frames Over 304" O.D. \$ 2.84 per I.D. Inch		

1 to 5 List Price 6 to 11 Less 5% 12 to 17 Less 7.5% 18 or more Less 10%

Total Frame I.D. Inches

140 \$ 478.50	144 492.00	148 505.00	152 509.50	156 523.00	160 536.50	164 540.50	168 554.00	172 567.50	176 572.00
180 585.50	184 599.00	188 603.50	192 617.00	196 630.50	200 635.00	204 648.50	208 662.50	212 667.00	216 680.50
220 694.50	224 699.00	228 712.50	232 726.50	236 731.00	240 745.00	244 759.00	248 763.50	252 777.50	256 791.50
260 796.00	264 810.00	268 824.00	272 828.50	276 843.00	280 857.00	284 861.50	Frames Over 284" I.D. \$ 3.04 per I.D. Inch		

1 to 5 List Price 6 to 11 Less 5% 12 to 17 Less 7.5% 18 or more Less 10%

Draw-Bar Options



Top Loading Double Nylon
Replacement Bars \$ 1.35 inch
Replacement Rods .20 inch



Keystone Nylon
Replacement Bars \$ 1.20 inch
Replacement Rods .15 inch



Glue On Draw Bars
Replacement Bars \$ 1.35 inch
Replacement Glue Strip .25 inch

Hardware Options



Hex Head
Replacement Bolt Set \$ 2.00 ea



Recessed Allen
Replacement Bolt Set \$ 2.00 ea

Eino / Diamond Chase
(800) 245-5283 ph
(626) 969-1821 ph
(626) 969-1599 fax

418 South Motor Ave.
Azusa, CA 91702

Additional 5% for New Frames with Recessed Allen Bolts
\$5.00 per Add'l Hole for Frames with 4" Bolt Centers
Prices Subject to Change without Notice

DRAW-BAR FRAME PRICE LIST



T-200

January 2021

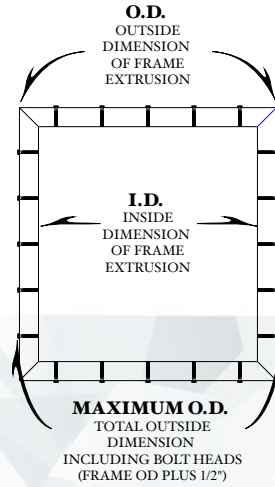
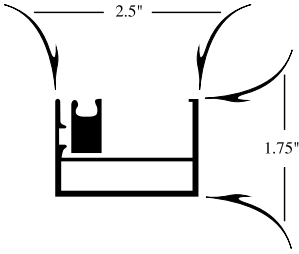

Max Size: 65"
 Width: 2 1/2"
 Height: 1 3/4"
 Weight per Ft: 1.7 Lbs
 ID to OD Conv: 5"
 ID to Max OD : 5 1/2"

Total Frame O.D. or Max O.D. Inches

160 \$ 473.00	164 486.50	168 499.50	172 503.50	176 517.00	180 530.00	184 534.50	188 547.50	192 561.00	196 565.00
200 578.50	204 592.00	208 596.50	212 610.00	216 623.50	220 627.50	224 641.00	228 654.50	232 659.00	236 672.50
240 686.00	244 690.50	248 704.00	252 718.00	256 722.00	260 736.00	264 749.00	268 752.50	272 765.50	276 779.00
280 782.50	284 795.50	288 808.50	292 812.00	296 825.00	300 838.50	304 842.00	Frames Over 304" I.D. \$ 2.77 per I.D. Inch		
1 to 5 List Price			6 to 11 Less 5%		12 to 17 Less 7.5%		18 or more Less 10%		

Total Frame I.D. Inches

140 \$473.00	144 486.50	148 499.50	152 503.50	156 517.00	160 530.00	164 534.50	168 547.50	172 561.00	176 565.00
180 578.50	184 592.00	188 596.50	192 610.00	196 623.50	200 627.50	204 641.00	208 654.50	212 659.00	216 672.50
220 686.00	224 690.50	228 704.00	232 718.00	236 722.00	240 736.00	244 749.00	248 752.50	252 765.50	256 779.00
260 782.50	264 795.50	268 808.50	272 812.00	276 825.00	280 838.50	284 842.00	Frames Over 284" O.D. \$ 2.97 per O.D. Inch		
1 to 5 List Price			6 to 11 Less 5%		12 to 17 Less 7.5%		18 or more Less 10%		

Draw-Bar Options



Top Loading Double Nylon
 Replacement Bars \$ 1.35 inch
 Replacement Rods .20 inch



Keystone Nylon
 Replacement Bars \$ 1.20 inch
 Replacement Rods .15 inch



Glue On Draw Bars
 Replacement Bars \$ 1.35 inch
 Replacement Glue Strip .25 inch

Hardware Options



Hex Head
 Replacement Bolt Set \$ 2.00 ea



Recessed Allen
 Replacement Bolt Set \$ 2.00 ea

Additional 5% for New Frames with Recessed Allen Bolts
 \$5.00 per Add'l Hole for Frames with 4" Bolt Centers
 Prices Subject to Change without Notice

Eino / Diamond Chase
 (800) 245-5283 ph
 (626) 969-1821 ph
 (626) 969-1599 fax

418 South Motor Ave.
 Azusa, CA 91702

DRAW-BAR FRAME PRICE LIST

January 2021

T-200 HD

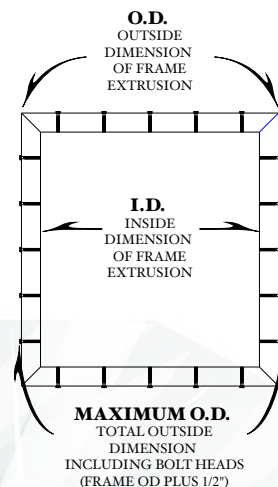
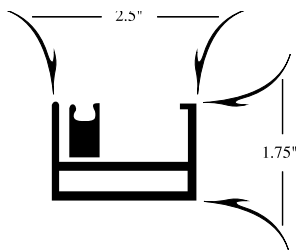
Max Size: 72"

Width: 2 1/2"

Height: 1 3/4"

Weight per Ft: 2.0 Lbs

ID to OD Conv: 5"

ID to Max OD : 5 1/2"

Total Frame O.D. or Max O.D. Inches

160 \$486.00	164 502.00	168 518.00	172 525.00	176 542.00	180 559.00	184 566.00	188 583.00	192 600.00	196 608.00
200 625.00	204 643.00	208 650.00	212 668.50	216 686.50	220 694.50	224 713.00	228 731.00	232 739.50	236 758.00
240 777.00	244 785.50	248 804.50	252 823.50	256 832.50	260 852.00	264 871.50	268 880.50	272 900.00	276 920.00
280 929.50	284 949.50	288 970.00	292 979.50	296 1000.00	300 1020.00	304 1030.00	Frames Over 304" O.D. \$ 3.39 per O.D. Inch		

1 to 5 List Price 6 to 11 Less 5% 12 to 17 Less 7.5% 18 or more Less 10%

Total Frame I.D. Inches

140 \$486.00	144 502.00	148 518.00	152 525.00	156 542.00	160 559.00	164 566.00	168 583.00	172 600.00	176 608.00
180 625.00	184 643.00	188 650.00	192 668.50	196 686.50	200 694.50	204 713.00	208 731.00	212 739.50	216 758.00
220 777.00	224 785.50	228 804.50	232 823.50	236 832.50	240 852.00	244 871.50	248 880.50	252 900.00	256 920.00
260 929.50	264 949.50	268 970.00	272 979.50	276 1000.00	280 1020.00	284 1030.00	Frames Over 284" I.D. \$ 3.63 per I.D. Inch		

1 to 5 List Price 6 to 11 Less 5% 12 to 17 Less 7.5% 18 or more Less 10%

Draw-Bar Options

Top Loading Double Nylon
 Replacement Bars \$ 1.35 inch
 Replacement Rods .20 inch

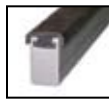
Keystone Nylon
 Replacement Bars \$ 1.20 inch
 Replacement Rods .15 inch

Glue On Draw Bars
 Replacement Bars \$ 1.35 inch
 Replacement Glue Strip .25 inch

Hardware Options

Hex Head
 Replacement Bolt Set \$ 2.00 ea

Recessed Allen
 Replacement Bolt Set \$ 2.00 ea

 Eino / Diamond Chase
 (800) 245-5283 ph
 (626) 969-1821 ph
 (626) 969-1599 fax

 418 South Motor Ave.
 Azusa, CA 91702

 Additional 5% for New Frames with Recessed Allen Bolts
 \$5.00 per Add'l Hole for Frames with 4" Bolt Centers
 Prices Subject to Change without Notice

DRAW-BAR FRAME PRICE LIST



T-250

January 2021

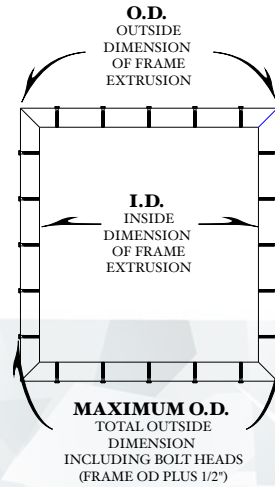
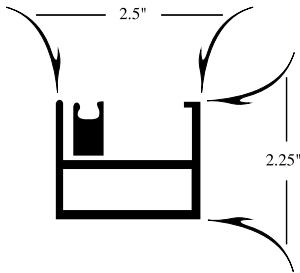

Max Size: 72"

Width: 2 1/2"

Height: 2 1/4"

Weight per Ft: 2.3 Lbs

ID to OD Conv: 5"

ID to Max OD : 5 1/2"

Total Frame O.D. or Max O.D. Inches									
180	184	188	192	196	200	204	208	212	216
\$643.00	651.50	669.50	687.50	696.50	715.00	733.50	742.50	761.00	780.00
220	224	228	232	236	240	244	248	252	256
789.50	808.50	828.00	837.50	857.00	877.00	886.50	906.50	927.00	937.00
260	264	268	272	276	280	284	288	292	296
957.50	978.00	988.50	1009.00	1030.00	1041.00	1062.00	1084.00	1095.00	1116.00
300	304	308	312	316	320	324	Frames Over 324" O.D.		
1138.00	1149.00	1171.00	1193.00	1205.00	1228.00	1250.00	\$3.86 per O.D. Inch		
1 to 5 List Price		6 to 11 Less 5%		12 to 17 Less 7.5%		18 or more Less 10%			

Total Frame I.D. Inches									
160	164	168	172	176	180	184	188	192	196
\$643.00	651.50	669.50	687.50	696.50	715.00	733.50	742.50	761.00	780.00
200	204	208	212	216	220	224	228	232	236
789.50	808.50	828.00	837.50	857.00	877.00	886.50	906.50	927.00	937.00
240	244	248	252	256	260	264	268	272	276
957.50	978.00	988.50	1009.00	1030.00	1041.00	1062.00	1084.00	1095.00	1116.00
280	284	288	292	296	300	304	Frames Over 304" I.D.		
1138.00	1149.00	1171.00	1193.00	1205.00	1228.00	1250.00	\$4.12 per I.D. Inch		
1 to 5 List Price		6 to 11 Less 5%		12 to 17 Less 7.5%		18 or more Less 10%			

Draw-Bar Options



Top Loading Double Nylon

Replacement Bars \$ 1.35 inch
Replacement Rods .20 inch



Keystone Nylon

Replacement Bars \$ 1.20 inch
Replacement Rods .15 inch



Glue On Draw Bars

Replacement Bars \$ 1.35 inch
Replacement Glue Strip .25 inch

Hardware Options



Hex Head

Replacement Bolt Set \$ 2.00 ea



Recessed Allen

Replacement Bolt Set \$ 2.00 ea

Additional 5% for New Frames with Recessed Allen Bolts
\$5.00 per Add'l Hole for Frames with 4" Bolt Centers
Prices Subject to Change without Notice

Eino / Diamond Chase
(800) 245-5283 ph
(626) 969-1821 ph
(626) 969-1599 fax

418 South Motor Ave.
Azusa, CA 91702

DRAW-BAR FRAME PRICE LIST

January 2021

T-300

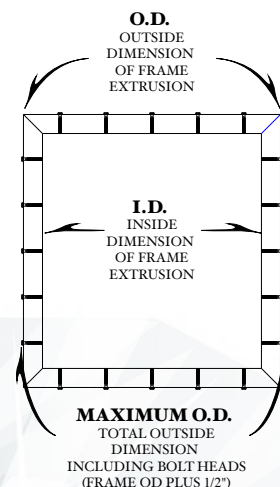
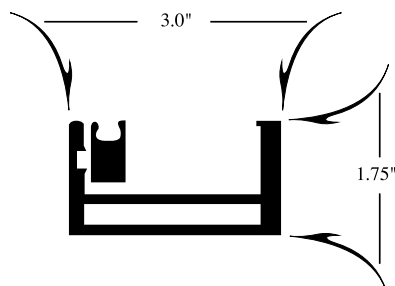

Max Size: 96"
 Width: 3"
 Height: 1 3/4"
 Weight per Ft: 2.5 Lbs
 ID to OD Conv: 6"
 ID to Max OD : 6 1/2"

Total Frame O.D. or Max O.D. Inches

220 \$ 865.50	226 889.00	232 912.50	238 936.50	244 960.00	250 985.00	256 1009.00	262 1034.00	268 1059.00	274 1084.00
280 1109.00	286 1134.00	292 1160.00	298 1186.00	304 1212.00	310 1238.00	316 1265.00	322 1292.00	328 1319.00	334 1346.00
340 1373.00	346 1400.00	352 1428.00	358 1456.00	364 1485.00	370 1513.00	376 1541.00	382 1570.00	388 1599.00	394 1628.00
400 1658.00	406 1687.00	412 1717.00	418 1747.00	424 1777.00	430 1808.00	436 1838.00	Frames Over 436" O.D. \$ 4.22 per O.D. Inch		
1 to 5 List Price			6 to 11 Less 5%			12 to 17 Less 7.5%			18 or more Less 10%

Total Frame I.D. Inches

196 \$ 865.50	202 889.00	208 912.50	214 936.50	220 960.00	226 985.00	232 1009.00	238 1034.00	244 1059.00	250 1084.00
256 1109.00	262 1134.00	268 1160.00	274 1186.00	280 1212.00	286 1238.00	292 1265.00	298 1292.00	304 1319.00	310 1346.00
316 1373.00	322 1400.00	328 1428.00	334 1456.00	340 1485.00	346 1513.00	352 1541.00	358 1570.00	364 1599.00	370 1628.00
376 1658.00	382 1687.00	388 1717.00	394 1747.00	400 1777.00	406 1808.00	412 1838.00	Frames Over 412" I.D. \$ 4.46 per I.D. Inch		
1 to 5 List Price			6 to 11 Less 5%			12 to 17 Less 7.5%			18 or more Less 10%

Draw-Bar Options

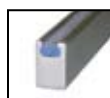

Top Loading Double Nylon
 Replacement Bars \$ 1.35 inch
 Replacement Rods .20 inch



Keystone Nylon
 Replacement Bars \$ 1.20 inch
 Replacement Rods .15 inch



Glue On Draw Bars
 Replacement Bars \$ 1.35 inch
 Replacement Glue Strip .25 inch

Hardware Options



Hex Head
 Replacement Bolt Set \$ 3.50 ea



Recessed Allen
 Replacement Bolt Set \$ 3.50 ea

Eino / Diamond Chase
 (800) 245-5283 ph
 (626) 969-1821 ph
 (626) 969-1599 fax

418 South Motor Ave.
 Azusa, CA 91702

Additional 5% for New Frames with Recessed Allen Bolts
 \$5.00 per Add'l Hole for Frames with 4" Bolt Centers
 Prices Subject to Change without Notice

DRAW-BAR FRAME PRICE LIST



MODEL 410

January 2021

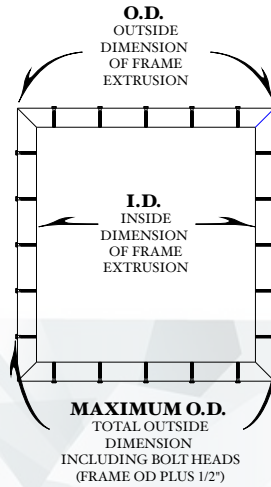
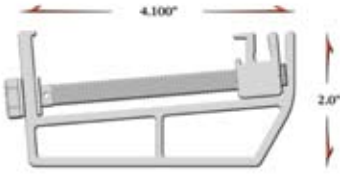

Max Size: 180"

Width: 4 1/8"

Height: 2"

Weight per Ft: 2.8 Lbs

ID to OD Conv: 8 1/4"

ID to Max OD : 8 3/4"

Total Frame O.D. or Max O.D. Inches

240 \$1083.00	246 1104.00	252 1125.00	258 1146.00	264 1167.00	270 1188.00	276 1209.00	282 1230.00	288 1252.00	294 1273.00
300 1294.00	306 1315.00	312 1336.00	318 1357.00	324 1379.00	330 1400.00	336 1421.00	342 1443.00	348 1464.00	354 1485.00
360 1507.00	366 1528.00	372 1549.00	378 1570.00	384 1592.00	390 1614.00	396 1635.00	402 1657.00	408 1678.00	414 1700.00
420 1721.00	426 1743.00	432 1764.00	438 1786.00	444 1808.00	450 1829.00	456 1851.00	Frames Over 456" O.D. \$ 4.06 per O.D. Inch		

1 to 5 List Price 6 to 11 Less 5% 12 or more Less 10%

Total Frame I.D. Inches

208 \$083.00	214 1104.00	220 1125.00	226 1146.00	232 1167.00	238 1188.00	244 1209.00	250 1230.00	256 1252.00	262 1273.00
268 1294.00	274 1315.00	280 1336.00	286 1357.00	292 1379.00	298 1400.00	304 1421.00	310 1443.00	316 1464.00	322 1485.00
328 1507.00	334 1528.00	340 1549.00	346 1570.00	352 1592.00	358 1614.00	364 1635.00	370 1657.00	376 1678.00	382 1700.00
388 1721.00	394 1743.00	400 1764.00	406 1786.00	412 1808.00	418 1829.00	424 1851.00	Frames Over 424" I.D. \$ 4.37 per I.D. Inch		

1 to 5 List Price 6 to 11 Less 5% 12 or more Less 10%

Draw-Bar Options



Top Loading Double Nylon
Replacement Bars \$ 1.35 inch
Replacement Rods .20 inch



Keystone Nylon
Replacement Bars \$ 1.20 inch
Replacement Rods .15 inch



Glue On Draw Bars
Replacement Bars \$ 1.35 inch
Replacement Glue Strip .25 inch

Hardware Options



Hex Head
Replacement Bolt Set \$ 3.50 ea

Additional 5% for New Frames with Recessed Allen Bolts
\$5.00 per Add'l Hole for Frames with 4" Bolt Centers
Prices Subject to Change without Notice

Eino / Diamond Chase
(800) 245-5283 ph
(626) 969-1821 ph
(626) 969-1599 fax

418 South Motor Ave.
Azusa, CA 91702

DRAW-BAR FRAME PRICE LIST

T-400 TRIPLE

January 2021

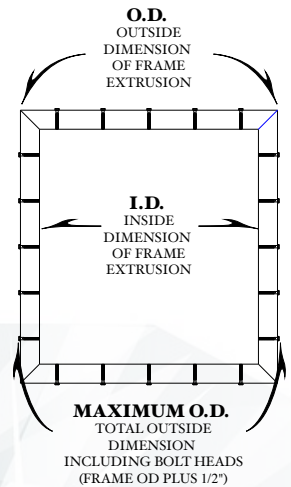
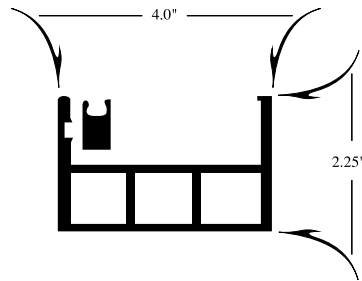

Max Size: 180"
 Width: 4"
 Height: 2 1/4"
 Weight per Ft: 3.0 Lbs
 ID to OD Conv: 8"
 ID to Max OD : 8 1/2"

Total Frame O.D. or Max O.D. Inches									
240	246	252	258	264	270	276	282	288	294
\$1114.00	1137.00	1160.00	1183.00	1206.00	1229.00	1252.00	1275.00	1299.00	1322.00
300	306	312	318	324	330	336	342	348	354
1345.00	1369.00	1393.00	1416.00	1440.00	1464.00	1488.00	1511.00	1535.00	1560.00
360	366	372	378	384	390	396	402	408	414
1584.00	1608.00	1632.00	1656.00	1680.00	1705.00	1730.00	1754.00	1779.00	1803.00
420	426	432	438	444	450	456	Frames Over 456" O.D.		
1828.00	1853.00	1878.00	1902.00	1927.00	1953.00	1978.00	\$ 4.34 per O.D. Inch		
1 to 5 List Price			6 to 11 Less 5%			12 or more Less 10%			

Total Frame I.D. Inches									
208	214	220	226	232	238	244	250	256	262
\$1114.00	1137.00	1160.00	1183.00	1206.00	1229.00	1252.00	1275.00	1299.00	1322.00
268	274	280	286	292	298	304	310	316	322
1345.00	1369.00	1393.00	1416.00	1440.00	1464.00	1488.00	1511.00	1535.00	1560.00
328	334	340	346	352	358	364	370	376	382
1584.00	1608.00	1632.00	1656.00	1680.00	1705.00	1730.00	1754.00	1779.00	1803.00
388	394	400	406	412	418	424	Frames Over 424" I.D.		
1828.00	1853.00	1878.00	1902.00	1927.00	1953.00	1978.00	\$ 4.67 per I.D. Inch		
1 to 5 List Price			6 to 11 Less 5%			12 or more Less 10%			

Draw-Bar Options



Top Loading Double Nylon
 Replacement Bars \$ 1.35 inch
 Replacement Rods .20 inch



Keystone Nylon
 Replacement Bars \$ 1.20 inch
 Replacement Rods .15 inch



Glue On Draw Bars
 Replacement Bars \$ 1.35 inch
 Replacement Glue Strip .25 inch

Hardware Options



Hex Head
 Replacement Bolt Set \$ 3.50 ea

Eino / Diamond Chase
 (800) 245-5283 ph
 (626) 969-1821 ph
 (626) 969-1599 fax

418 South Motor Ave.
 Azusa, CA 91702

Additional 5% for New Frames with Recessed Allen Bolts
 \$5.00 per Add'l Hole for Frames with 4" Bolt Centers
 Prices Subject to Change without Notice

DRAW-BAR FRAME PRICE LIST



T-500 TRIPLE

January 2021

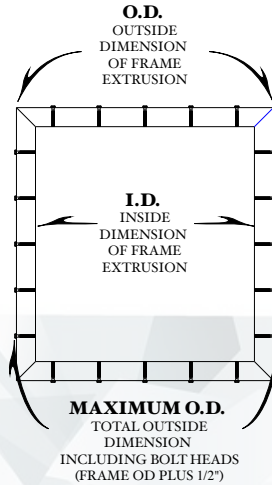
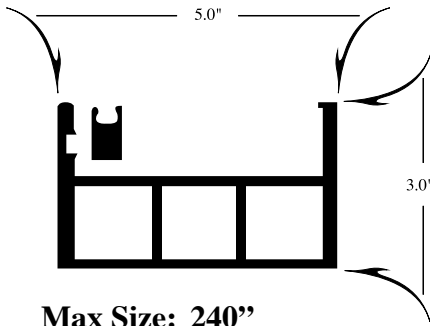

Max Size: 240"

Width: 5"

Height: 3"

Weight per Ft: 3.8 Lbs

ID to OD Conv: 10"

ID to Max OD : 10 1/2"

Total Frame O.D. or Max O.D. Inches

300	310	320	330	340	350	360	370	380	390
\$ 1608.00	1657.00	1707.00	1744.00	1794.00	1844.00	1882.00	1933.00	1984.00	2023.00
400	410	420	430	440	450	460	470	480	490
2074.00	2126.00	2165.00	2217.00	2269.00	2309.00	2362.00	2415.00	2455.00	2508.00
500	510	520	530	540	550	560	570	580	590
2562.00	2603.00	2657.00	2711.00	2752.00	2807.00	2862.00	2904.00	2959.00	3015.00
600	610	620	630	640	650	660	Frames Over 660" O.D.		
3057.00	3113.00	3169.00	3212.00	3269.00	3325.00	3369.00	\$ 5.10 per O.D. Inch		

1 to 2 List Price 3 to 6 Less 5% 7 or more Less 10%

Total Frame I.D. Inches

260	270	280	290	300	310	320	330	340	350
\$ 1608.00	1657.00	1707.00	1744.00	1794.00	1844.00	1882.00	1933.00	1984.00	2023.00
360	370	380	390	400	410	420	430	440	450
2074.00	2126.00	2165.00	2217.00	2269.00	2309.00	2362.00	2415.00	2455.00	2508.00
460	470	480	490	500	510	520	530	540	550
2562.00	2603.00	2657.00	2711.00	2752.00	2807.00	2862.00	2904.00	2959.00	3015.00
560	570	580	590	600	610	620	Frames Over 620" I.D.		
3057.00	3113.00	3169.00	3212.00	3269.00	3325.00	3369.00	\$ 5.43 per I.D. Inch		

1 to 2 List Price 3 to 6 Less 5% 7 or more Less 10%

Draw-Bar Options



Top Loading Double Nylon
Replacement Bars \$ 1.35inch
Replacement Rods .20 inch



Keystone Nylon
Replacement Bars \$ 1.20 inch
Replacement Rods .15 inch



Glue On Draw Bars
Replacement Bars \$ 1.35 inch
Replacement Glue Strip .25 inch

Hardware Options



Hex Head
Replacement Bolt Set \$ 4.50 ea

Additional 5% for New Frames with Recessed Allen Bolts
\$5.00 per Add'l Hole for Frames with 4" Bolt Centers
Prices Subject to Change without Notice

Eino / Diamond Chase
(800) 245-5283 ph
(626) 969-1821 ph
(626) 969-1599 fax

418 South Motor Ave.
Azusa, CA 91702

DRAW-BAR FRAME PRICE LIST

January 2021



CYLINDER PRESS FRAMES

Diamond Chase specifically developed a frame profile to work with cylinder presses and cylinder presses with master frame carriers. Diamond Chase frames are easily integrated with existing bar frames. Choose between the standard Keystone, Shur-Loc or Glue-on fabric locking systems.

**On Press Micro Registration
+/- 1 N/cm Tensioning Ability**

**Welded Water Tight
Keystone, Shur-Loc® and Glue-on
Locking Systems**

Model	O.D. Size	1 to 5	6 to 11	12 Plus
Model 15/20	31 1/8" x 31 3/4"	445.00	422.75	400.50
Model 20/28	35 3/4" x 35 1/4"	487.50	463.13	438.75
Model 23/28	37 1/4" x 35 3/4"	492.00	467.40	442.80
Model 28/40	45 3/4" x 50 3/4"	608.50	578.08	547.65
Model 31/44	51 3/4" x 55 3/4"	665.50	632.23	598.95
Model DX	46 1/2" x 52"	621.25	590.19	559.13
Model 20/28 MS	36" x 36"	489.65	465.17	440.68

Draw-Bar Options



Keystone Nylon
Replacement Bars \$ 1.35 inch
Replacement Rods .15 inch



Glue On Draw Bars
Replacement Bars \$ 1.45 inch
Replacement Glue Strip .25 inch

Hardware Options



Hex Head
Replacement Bolt Set \$ 2.00 ea

Eino / Diamond Chase
(800) 245-5283 ph
(626) 969-1821 ph
(626) 969-1599 fax

418 South Motor Ave.
Azusa, CA 91702

Additional 5% for New Frames with Recessed Allen Bolts
\$5.00 per Add'l Hole for Frames with 4" Bolt Centers
Prices Subject to Change without Notice

CYLINDER FRAME DRAW-BAR SETS

(INCLUDES LOCKING RODS)



DIAMOND
CHASE

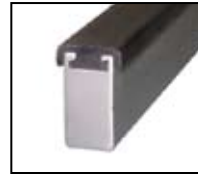

	Keystone	Tall SAK Kst.	Glue-On
Model 15/20 (2 @ 25 5/8" & 2 @ 26 1/4")	\$ 124.50	\$140.06	\$150.44
Model 20/28 (2 @ 30 1/4" & 2 @ 29 3/4")	144.00	162.00	174.00
Model 23/28 (2 @ 31 3/4" & 2 @ 30 1/4")	148.80	167.40	179.80
Model 28/40 (2 @ 40 1/4" & 2 @ 45 1/4")	205.20	230.85	247.95
Model 31/44 (2 @ 46 1/4" & 2 @ 50 1/4")	231.60	260.55	279.85
Model DX (2 @ 41" & 2 @ 46 1/2")	210.00	236.25	253.75
Model 20/28 MS (4 @ 30 1/2")	146.40	164.70	176.90

CYLINDER FRAME BOLT SETS & NYLON SETS

Replacement Bolt Set
\$ 2.00 ea
(1 Bolt, 2 Washers, 1 Pin)



	Locking Rod Sets	Hex Bolt Sets
Model 15/20	\$ 15.86 (2 @ 26 1/8" & 2 @ 26 3/4")	\$36.00 (18 per Frame)
Model 20/28	18.30 (2 @ 30 3/4" & 2 @ 30 1/4")	40.00 (20 per Frame)
Model 23/28	18.90 (2 @ 32 1/4" & 2 @ 30 3/4")	40.00 (20 per Frame)
Model 28/40	25.95 (2 @ 40 3/4" & 2 @ 45 3/4")	60.00 (30 per Frame)
Model 31/44	29.25 (2 @ 46 3/4" & 2 @ 50 3/4")	68.00 (34 per Frame)
Model DX	26.55 (2 @ 41 1/2" & 2 @ 47")	60.00 (30 per Frame)
Model 20/28 MS	18.60 (4 @ 31")	40.00 (20 per Frame)

Prices Subject to Change without Notice

Eino / Diamond Chase
(800) 245-5283 ph
(626) 969-1821 ph
(626) 969-1599 fax

418 South Motor Ave.
Azusa, CA 91702

REPLACEMENT PARTS PRICE LIST

January 2021

BOLT SETS (1 Bolt, 2 Washers, 1 Pin)

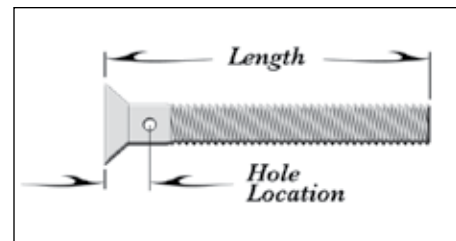
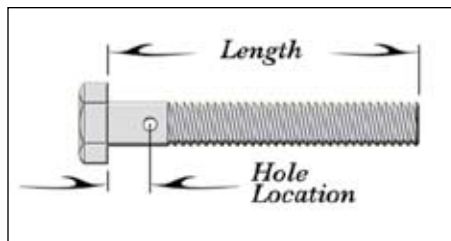

Frame Model	Bolt Length	Hole Dimension	Bolt Set
WC-10 (Hex, Allen, Rec. Allen)	1 ¼"	No Hole	\$1.50 each
LJ-20 (Hex, Allen, Rec. Allen)	2"	.300	\$2.00 each
WC-20 (Hex, Allen, Rec. Allen)	2"	.420	\$2.00 each
WC-20 HD (Allen)	2"	.420	\$2.00 each
WC-20 HD (Raised Hex)	2 ½"	.920	\$3.00 each
T-175 (Hex, Allen, Rec. Allen)	1 ¾"	.420	\$2.00 each
T-175 HD (Hex, Allen, Rec. Allen)	2 ½"	.420	\$2.00 each
UC 25 (Hex, Allen, Rec. Allen)	2 ½"	.355	\$2.00 each
T-200 (Hex, Allen, Rec. Allen)	2 ½"	.300	\$2.00 each
T-200 HD (Hex, Allen, Rec. Allen)	2 ½"	.355	\$2.00 each
T-250 (Hex, Allen, Rec. Allen)	2 ½"	.355	\$2.00 each
T-300 (Hex Head, Rec. Allen)	3"	.420	\$3.50 each
T-400 Triple (Hex Head Only)	4"	.355	\$3.50 each
T-500 Triple (Hex Head Only)	5"	.420	\$4.50 each
Cylinder Press Frames (Hex Only)	2 ¼"	.300	\$2.00 each

LOCKING RODS

 Wedge Style
Keystone Nylon

 Round Double
Top Loading

 Glue-On
Inserts

Keystone (Cut to Length)	p/n NYLKST	\$.15 per Inch
Round (White - High Mesh) Cut to Length	p/n NYLONWT	\$.20 per Inch
Round (Blue - Medium Mesh) Cut to Length	p/n NYLONBL	\$.20 per Inch
Round (Black - Low Mesh) Cut to Length	p/n NYLONBK	\$.20 per Inch
Glue On Insert (Cut to Length)	p/n DIINSERT	\$.25 per Inch

Round Rod 15 Foot Lengths

\$ 27.00 each

MISC HARDWARE

Washers (5/16" or 1/4" & .0625 or .031 Thick)	\$.20 each
Aluminum Spacer for WC-20 Raised Hex	\$.55 each
3/32" Diameter Bend Pins (Tool Kit Required)	.45 each
3/32" Diameter Groove Pins	.45 each
Draw-Bar Threaded Insert (5/16-18, 1/4-20 or 8mm x 1.25)	1.00 each

Prices Subject to Change without Notice

 Eino / Diamond Chase
 (800) 245-5283 ph
 (626) 969-1821 ph
 (626) 969-1599 fax

 418 South Motor Ave.
 Azusa, CA 91702

REPLACEMENT DRAW-BAR



PRICE LIST January 2021

DOUBLE NYLON LOCKING SYSTEM

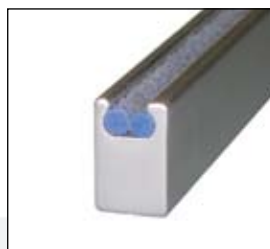

Top Loading Double

Double nylon system where both locking rods snap in together from the top of the draw bar with the assistance of a wheel type insertion tool.

Great all around fabric locking system.

Height .875" (22.2 mm)

Width .562" (14.3 mm)

1/4" or 5/16" Hardware

\$ 1.35 per Inch

KEYSTONE LOCKING SYSTEM



Standard Keystone

Single rod fabric locking system where the rods is slid in from the end of the draw bar. Keystone has increased pre-tensioning ability and works well with stainless meshes.

Height .940" (23.9 mm)

Width .500" (12.7 mm)

1/4" or 5/16" Hardware

\$ 1.20 per Inch



Cylinder Press Keystone

Taller Draw-Bar with the Keystone locking system is designed to fit cylinder press frames. Same benefits as the regular Keystone system with added durability.

Height 1.165" (30.1 mm)

Width .562" (14.3 mm)

5/16" Hardware only

\$ 1.35 per Inch



Dual Keystone

This combination draw bar has both the Keystone locking system and a separate groove to fit pre-made Shur-Loc* fabric panels. Increased width adds durability and strength.

Height .938" (23.8 mm)

Width .625" (15.9 mm)

1/4" or 5/16" Hardware



Eino / Diamond Chase
(800) 245-5283 ph
(626) 969-1821 ph
(626) 969-1599 fax

418 South Motor Ave.
Azusa, CA 91702

Prices Subject to Change without Notice

REPLACEMENT DRAW-BAR PRICE LIST

January 2021

GLUE-ON SYSTEMS (ALL METAL)

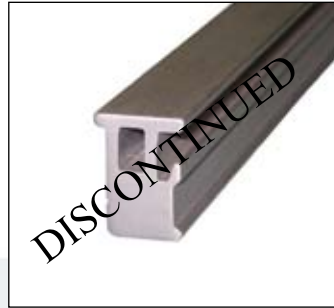

Glue-On Aluminum

Increased fabric tensions by using the stretch & glue method for the primary tensioning. Hardware on the frame is only used for re-tensioning. All metal construction allows for the use of chemical stripping of old adhesive.

Height 1.000" (25.4 mm)
Width .750" (19 mm)
1/4" or 5/16" Hardware



Cylinder Press Glue-On

Taller Draw-Bar allows for gluing contact during the primary Stretch & Glue process when using cylinder press frames. All metal construction allows for the use of chemical stripping of old adhesive.

Height 1.150" (29.2 mm)
Width .750" (19 mm)
5/16" Hardware only

\$ 1.45 per Inch

DETACHABLE INSERT GLUE-ON



D.I. Glue-On

Increased fabric tensions by using the stretch & glue method for the primary tensioning. Hardware on the frame is only used for re-tensioning. Detachable insert bonds excellent and can be replaced for cleaning.

Height 1.000" (25.4 mm)
Width .750" (19 mm)
1/4" or 5/16" Hardware

\$ 1.35 per Inch



Cylinder D.I. Glue-On

Taller Draw-Bar allows for gluing contact during the primary stretch & glue process when using cylinder press frames. Detachable insert bonds excellent and can be replaced for cleaning.

Height 1.250" (31.8 mm)
Width .750" (19 mm)
5/16" Hardware only

\$ 1.45 per Inch

Eino / Diamond Chase
(800) 245-5283 ph
(626) 969-1821 ph
(626) 969-1599 fax

418 South Motor Ave.
Azusa, CA 91702

Prices Subject to Change without Notice

PIN INSTALLATION KIT



DIAMOND
CHASE

Kit Includes:

Bolt Stabilizer
Pin Shear Tool
Pin Bend Tool

\$ 60.00 Each



BOLT STABILIZER



The bolt stabilizer aides in holding the head of the bolt when both shearing and bending.

PIN SHEARING



The pin shearing tool cuts the old pin on both side of the bolt with a hit of a hammer.

PIN BENDING



The pin bending tool easily retains the pin around the bolt by forming it in an arc.

INSPECTION



The new bolt / pin replacement

Always Wear Safety Glasses

Prices Subject to Change without Notice

Eino / Diamond Chase
(800) 245-5283 ph
(626) 969-1821 ph
(626) 969-1599 fax

418 South Motor Ave.
Azusa, CA 91702

DRAW-BAR FRAME PRICE LIST

January 2021

PRE-BOW

Two Sides \$ 40.00 per set

Recommend Pre-Bow

1 1/2" to 2 1/2" Profiles	.375" to .500" per side
2 1/2" to 3" Profiles	.500" to .750" per side
3" to 5" Profiles	.750" to 1.500" per side

THREADED INSERTS

Flush Mount, Watertight, Stainless Insert
1/4-20, 5/16-18 or 8mm x 1.25

\$ 21.00 each
\$ 30.00 set-up

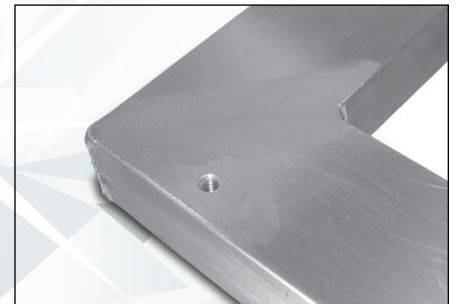

LOCATOR BUSHINGS

Aluminum Plug Drilled \$ 22.50 each
Flush Mount, Watertight \$ 30.00 set-up

Bronze Bushing \$ 25.00 each
Flush Mount, Watertight \$ 30.00 set-up

Stainless Steel Bushing \$ 25.00 each
(Labor Only) \$ 30.00 set-up

Flush Mount, Watertight
Stainless Steel Bushing Call for Quote

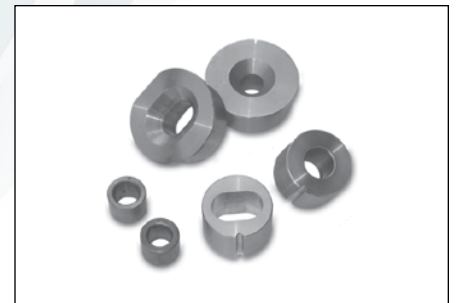

CORNER GUSSETS

Large Format Stretch & Glue Frames
\$ 100.00

Large Format Draw-Bar Frames
\$ 100.00

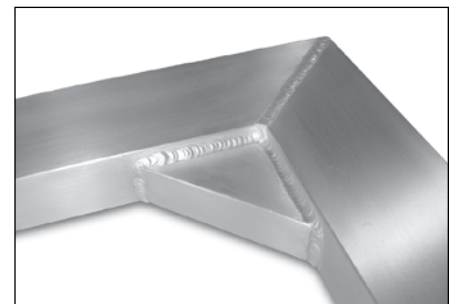

Eino / Diamond Chase
(800) 245-5283 ph
(626) 969-1821 ph
(626) 969-1599 fax

418 South Motor Ave.
Azusa, CA 91702

Additional 5% for New Frames with Recessed Allen Bolts
\$5.00 per Add'l Hole for Frames with 4" Bolt Centers
Prices Subject to Change without Notice

REPLACEMENT PARTS PRICE LIST

January 2021



INSERTION TOOL

Wheel Type Insertion Tool
Top Loading Double Nylon Only

\$ 30.00 each



Acrylic Plastic Card
All Double Nylon and Keystone

\$ 3.00 each



INSTRUCTIONAL VIDEOS

Draw-Bar Frame
Tension Quick Fabric Stretcher
Roller Chase

AVAILABLE ONLINE ONLY

MICRO CHASE FRAMES

5" x 5" I.D.	\$67.50
5" x 7" I.D.	83.50
8" x 10" I.D.	90.00



MICRO CHASE REBUILD KITS

Replacement Draw-Bars (with Locking Rods)
5" x 5" I.D. Call for Quote
5" x 7" I.D.
8" x 10" I.D.

Replacement Bolts
Stainless Steel Recessed Allen

Prices Subject to Change without Notice

Eino / Diamond Chase
(800) 245-5283 ph
(626) 969-1821 ph
(626) 969-1599 fax

418 South Motor Ave.
Azusa, CA 91702



Eino
PRODUCTS



**DIAMOND
CHASE**

418 South Motor Avenue
Azusa, CA 91702
(800) 245-5283 ph
(626) 969-1821 ph
(626) 969-1599 fax